

Linear Actuators for Vehicles

EM28ASL

【Characteristic】

- Small / lightweight
- Vibration resistance
- Heat resistance, moisture absorption resistance, gasoline resistance
- Pb Free
- RoHS Compliant

【Main Specifications】

- 2-phase gear
- Drive type bipolar drive
- Step angle 15 ° / step
- Rated voltage DC12V



Appearance numerical value,
characteristic example

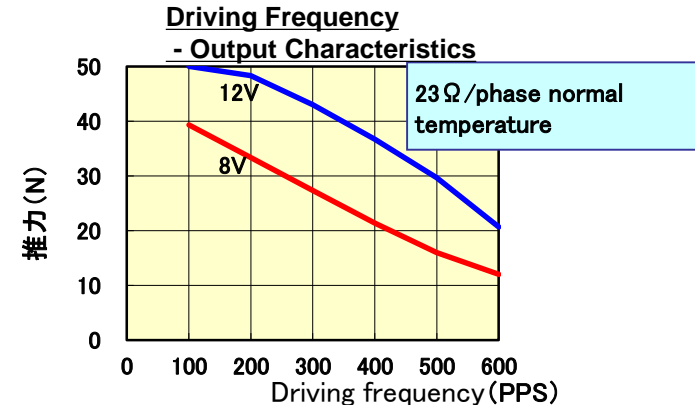
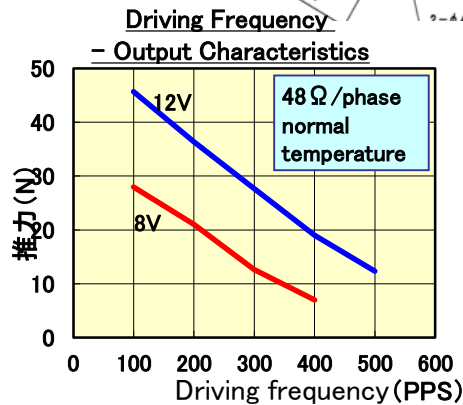
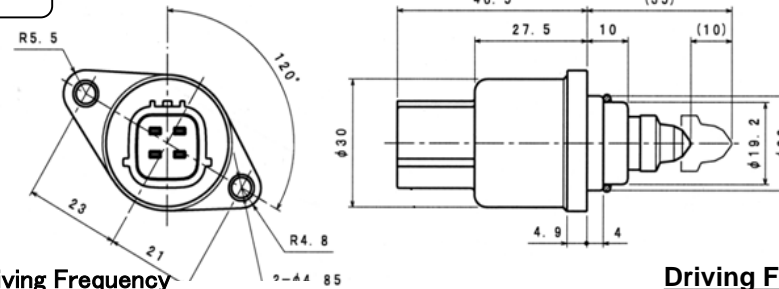

In addition, the output characteristic is the actual value at room temperature, not guaranteed value.

Linear Actuators for Vehicles

EM20ASL·EM20ASR

【Characteristic】

- Small / lightweight
- Vibration resistance
- Heat resistance, moisture absorptio resistance
- Pb Free
- RoHS Compliant

【Main Specifications】

- Two-phase leader
- Drive type bipolar drive
- Step angle 18 ° / step
- Rated voltage DC12V

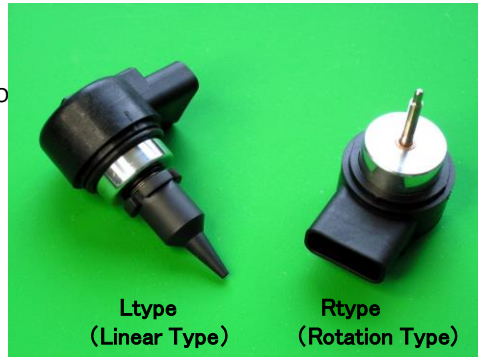

Appearance numerical value, characteristic example

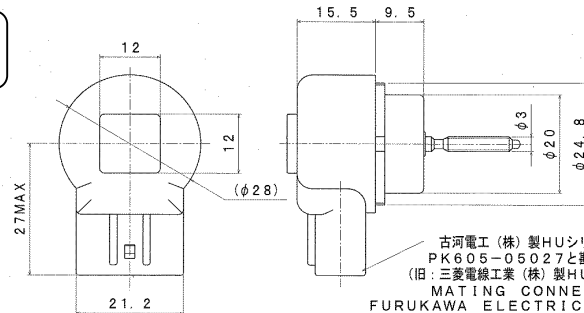

古河電工 (株) 製HUシリーズ
PK605-05027と動合仕様
(旧:三菱電線工業 (株) 製HUシリーズ)
MATING CONNECTOR
FURUKAWA ELECTRIC CO., LTD.
PK605-05027

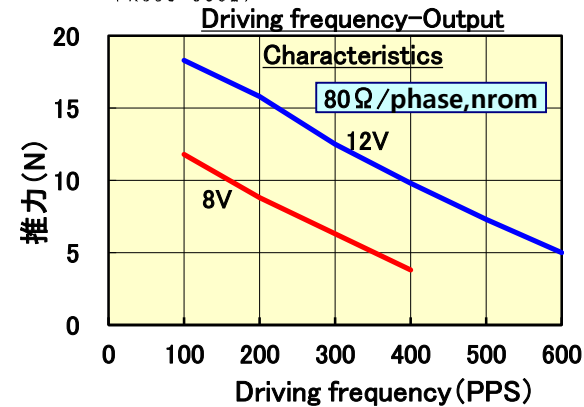
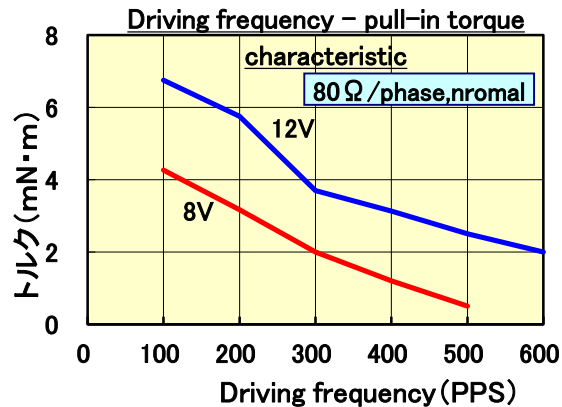

In addition, the output characteristic is the actual value at room temperature, not guaranteed value.